



WORKING PAPER #57

THE IMPACT OF ELECTRIC VEHICLE FLEETS ON THE EUROPEAN ELECTRICITY MARKETS: EVIDENCE FROM THE GERMAN PASSENGER CAR FLEET AND POWER GENERATION SECTOR

Maria Juliana Suarez Forero, Frédéric Lantz, Pierre Nicolas, Patrice Geoffron



Dauphine | PSL 
CHAIRE EUROPEAN ELECTRICITY MARKETS

Chaire de recherche soutenue par



edf > epexspot



TOTAL
direct energie

The impact of Electric Vehicle fleets on the European electricity markets: evidences from the German passenger car fleet and power generation sector

Maria Juliana SUAREZ FORERO^{1,2,3,*}, Frederic LANTZ¹, Pierre NICOLAS², Patrice GEOFFRON³

November 2021

Abstract

The rapidly increasing participation of renewable energies (REn) into the electric mix, clearly traces the trends for the decarbonization goals in the European Union. Under the priority sale conditions established by governments, the commercialization of REn plays an important role in the consolidation of market prices, which are on a decreasing trend with large fluctuations that reduce the profit in the power sector and therefore, the interest of potential investors. The incorporation of small power capacities, available with a considerable fleet of electric vehicles (EV) disposed to support the bulk power system through an intelligent, and possibly bidirectional recharging system (the vehicle grid integration VGI), could have a positive impact on the electricity market as well as in CO_2 emissions. In this context, our purpose is to simulate the impact of a large development of EV on the electricity market and the economic surplus of the power sector. Through a VGI tool that includes an algorithm of smart charging, we simulate the behavior of a fleet composed by some millions of EV as follows: a decentralized VGI algorithm of smart charging included in each EV estimates the energy consumption in time of the EV fleet. For a specific number of EV, we simulate the aggregated charge on the power grid, and anticipate the total expected load curve for one day. We use the estimated load curve as input in an electricity market model for calculating the producer's surplus over one year. We show that the increasing EV fleet significantly decreases the fluctuation of the residual electricity demand as well as the electricity price. Consequently, this has a positive impact on the surplus of the sector.

Keywords: Energy transition, Electricity markets, Merit order effect, Vehicle grid integration.

Acknowledgments: This paper has benefited from the support of the Chaire European Electricity Markets (CEEM) of the Université Paris-Dauphine under the aegis of the Foundation Paris-Dauphine, supported by RTE, EDF, EPEX Spot and Total Energies.

Disclaimer: The views and opinions expressed in this paper are those of the authors and do not necessarily reflect those of the partners of the CEEM.

¹ IFP Energies Nouvelles, IFP School

² Renault, Research and Development Department

³ Paris Dauphine University, LEDa, Chair European Electricity Markets

* Corresponding author: majsuarezf@gmail.com

I. INTRODUCTION

The growing interest in supplying electricity from renewable energy (REn) sources and in deploying cleaner mobility systems lies in the low carbon energy transition context all around the world. Europe, concerned and worried about the climate change, expects to reach the carbon neutrality by 2050. To do so, EU defined specific targets for REn deployment through the *Renewable Energy Directive*. The target was initially set at a level of 32% of REn in final consumption by 2030. This target was updated to 40% in the new legislation package released on July 14th 2021 by the European Commission. By this date, it announced its new project to mitigate the climate change, *Fit for 55*, and set the ambitious target of reducing 55% of the greenhouse gas emissions (GGE) by 2030. Reaching this level requires to accelerate investments in wind power and solar power generation units at a rate that could represent in Europe 35% of the electricity supply by 2030, and even rates around or above 50% in countries such as Germany. By 2050, 80% of the electricity supply is expected to be produced from renewable sources [7–9, 12]. However, the power supply from these resources is intermittent and a massive deployment will require new flexibility technologies to ensure the equilibrium between electricity demand and supply. So far, thermal power plants, Pumped Storage Hydropower (PSH) plants¹ and demand side management are the main used methods for setting the equilibrium demand/supply. These capacities risk to approach their limits in a high variable system, though. In this context, Electric vehicles (EV) may well become a resource able to bring flexibility. Their interaction with the power system through the **Vehicle Grid Integration** (VGI) concept is the core of this research. This integration is two-fold in the decarbonization goals: to reach the objective of getting a cleaner mobility and to assist adequacy and reliability in more renewable electricity mixes.

The electricity production from REn plays an important role in the establishment of market prices. As an essential instrument for governments to achieve the objectives of reducing CO_2 emissions, REn have had a priority place in the sale of their production in the merit order system² with special remuneration mechanisms such as *feed-in tariff* and *feed-in premium*. The marginal cost of REn plants is almost zero, hence, bids on the market can have negative values, up to a price lower in absolute value than the amount of the grant, and there is still a positive remuneration for these energies. There is a minimal production threshold from where thermal power plants cannot go down. Therefore, sometimes producers with thermal power plants must bid their production at negative values during off-peak hours and at positive values during the peak production hours. The technical limitations to slowly ramp-up production up to a certain level force them to set a price that guarantees that the market will buy their

¹Pumped storage hydropower represents 94% of the worldwide storage capacity for electricity according to the International Hydropower Association (IHA) but their construction is not accessible to all kind of territories.

²All power producers offer the electricity quantity they are able to produce at an specific time of the next day at a price that equals its marginal cost. The lowest cost producers are assigned at first, then the next lowest ones and so on until reaching the last required dispatching unit for supplying demand. All producers are remunerated at the marginal cost of the last dispatched unit.

daily production. It is under certain conditions of electricity demand and supply that the equilibrium price decreases and fixes the market price at a negative value: when there is an overproduction that can no longer be stored or exported due to simultaneous overproduction in other countries [1]. In the opposite situation, when production from RE_n is low, consumption is high and imports are at its maximal capacity, market price is fixed by the most expensive thermal power plants even at higher values than their marginal costs, the scarcity prices. Both situations become more recurrent while high RE_n capacities are deployed.

II. ENERGY TRANSITION CONTEXT IN EUROPE

2.1. The flexibility needs of the electricity sector

The development of intermittent RE_n involves large fluctuations in the power generation, creating peaks and valleys on the supply demand curves. Consequently, there is a flexibility requirement. A large literature on this topic exists both from a technical and an economics point of view. With an increasing implementation of RE_n in the electricity mix, the management of large fluctuations of the power supply becomes a problem for grid operators [16], [31]. This is a major issue since the high variability of these renewable resources is reflected in the failures of the electricity market through negative prices, high price variability or insufficient long-term incentives [31]. According to reference [24], without storage systems, the substitution of conventional power resources by RE_n leads to the called *merit order effect*: this is the decrease of market prices that brings power plants to disrupt because they are not profitable enough. As pointed by reference [21], in periods of high electricity production fluctuation it has been observed that the wholesale power price changes its usual behavior: when demand is high, market prices exceed variable costs while when demand is low, market prices fail under variable costs. Other research approach more technical issues of the RE_n integration. For example, results from reference [30] show that a power system with high RE_n penetration leads to significant losses through curtailment. The calculated losses are of around 18% in a mix with 50% of RE_n installed capacity. The increase of economic and technical problems has conducted most of the EU countries to review and upgrade their financial support schemes [31] such as the complement remuneration or the previously mentioned, *feed-in tariff* and *feed-in premium*, and to evaluate the different flexibility technologies. The challenge for the power system is thereby to find the balance between the targets of RE_n penetration in the electricity mix, and the flexibility needs, which are increasing at the same time.

The flexibility of a power system is its capacity of adaptation to variations coming from demand and production. To do so, thermal power plants ramp -up or -down their production and PSH plants fill or empty their reservoirs. Given the interconnections of power systems between neighboring countries, imports and exports are performed as well for dispatching overproduction and for supplying demand when there is a local production shortage. Nevertheless, when these power plants and interconnection grids reach their technical boundaries, the production system does not have how to

	2010	2011	2012	2013	2014	2015	2016	2017	2018	2019
Germany	42.3	42.9	43.4	43.8	44.4	45	45.8	46.4	47.1	47.7
Italy	36.7	37.1	37	36.9	37	37.3	37.8	-	39	39.5
France	31.6	31.7	32.1	32.8	32.5	32.3	32	32	32	32.4
U.K.	28.4	28.4	28.7	-	-	30.2	30.8	31.2	31.5	-
Spain	22.1	22.2	22.2	22	22	22.3	22.8	23.5	24	24.5
Poland	17.2	18.1	18.7	19.3	20	20.7	21.6	22.5	23.4	24.3

Table 1: Main passenger car fleets in Europe from 2010 to 2019 in millions. Source: Eurostat. Unit: million cars.

absorb variations and a tight market situation occurs. RTE, the French transmission system operator (TSO) observed in the case of France and Germany, that the French nuclear power supply is modulated as a function of German REn production and that this can result in negative prices on the electricity market [27]. Figure 1 shows an example of these situations in April 2020, when weather conditions were particularly good while demand was particularly low because of the lockdown. On April 13th 2020 at 3:00pm the German market price reached $-78,15 \text{ €/MWh}$ and the French market price was fixed at $-75,82 \text{ €/MWh}$. By this time, there was an overproduction of the German power system which was absorbed through the French nuclear power with a modulation of 15 GW under its average generation value³. The European market integration is an important target to improve the efficiency of the electricity supply. Some long term factors impacting this market integration are the specific stakeholders' initiatives and the expansion of interconnection capacities, while the short term factors include technical issues producing outages and sudden demand or supply changes (for example a high REn production with a very low demand). The region including French and German bidding zones reached full price convergence in around 48% of the hours in the year 2020 according to reference [11]. Following the definition of convergence from reference [17], i.e. the situation in which the price difference is lower than 0.1 €/MWh , the integration of more REn capacities will produce more divergence in market prices, which is an evidence of market inefficiency.

2.2. The passenger vehicles

During the last decades, the use of passenger cars has evolved as well as the fuels for powering them. According to the European Commission's report [10], by 2018 there were more than 47 million passenger cars registered in Germany and 32 million in France. Both vehicle fleets have remained stable through the last years, therefore, sales correspond mainly to replacement markets. In Germany, 3.6 million of new cars were sold in 2019 and 2.9 million in 2020. In France, 2.2 million of new cars were sold in 2019 and 1.6 million in 2020. While these new cars integrate a country fleet, a part of the existent fleet must go out because cars do not suffice current policies anymore. To this purpose, different end-of-life strategies are applied in each country, and as result,

³In 2019, Germany exported electricity during 72% of the time and imported electricity during the remaining 28% of the year. Germany exports its electricity mainly to Austria, Poland and Switzerland and imports mainly from France. The order of magnitude of imports and exports is some tens of TWh per year. <https://www.ise.fraunhofer.de/en/press-media/news/2019/Public-net-electricity-generation-in-germany-2019.html>

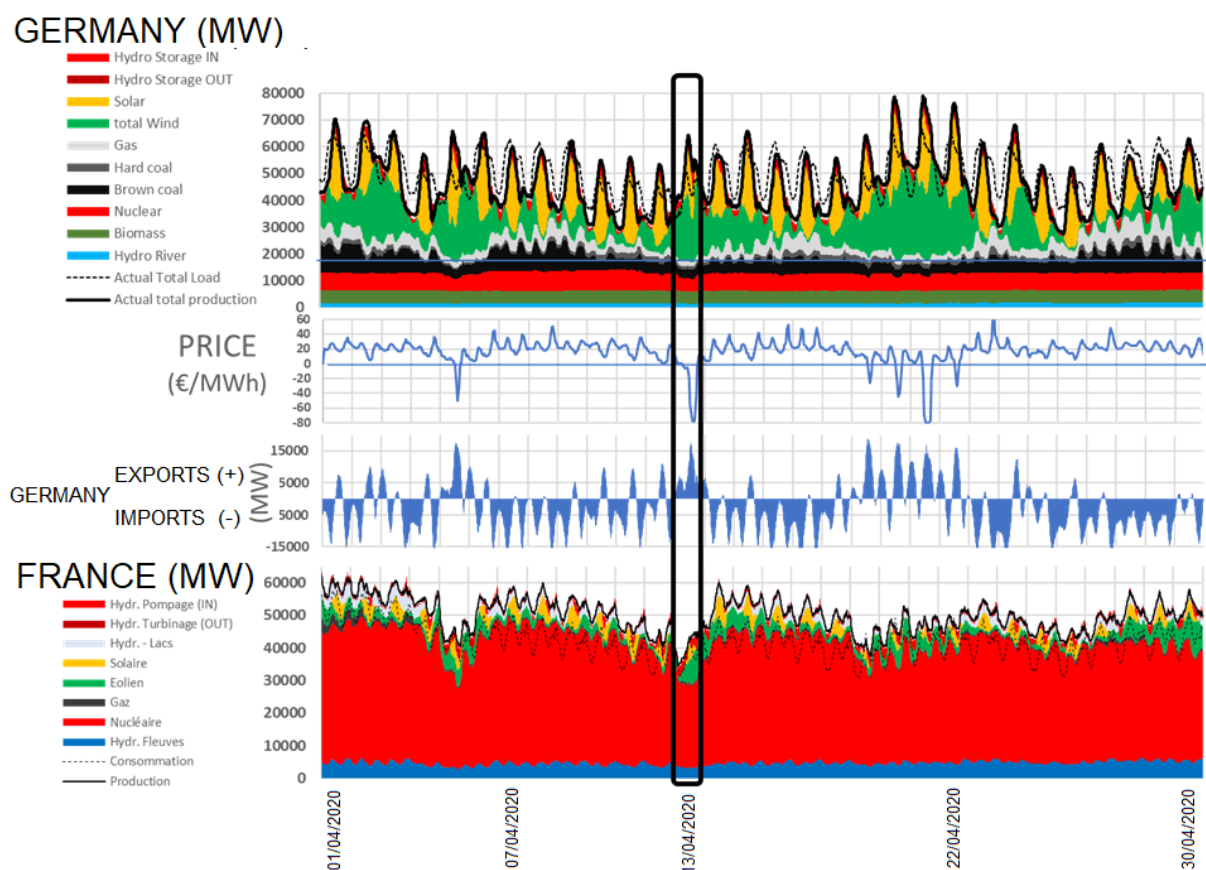

Figure 1: French and German electricity generation, German exports and imports and German *day ahead* prices in April 2020. Marker on the 13th of April 2020 at 3pm. Source: authors with original data from ENTSOE. Unit: production [MW], price [€/MWh].

around 3 million vehicles are decommissioned every year in Germany while in France the corresponding amount is 1.3 million cars. The evolution of the most important passenger cars fleets in Europe from 2010 to 2019 are presented in Table 1.

From 2018 to 2020, in Germany and France, around 60% of new vehicle registrations correspond to petrol powered cars and 32% and 38% respectively, correspond to diesel powered cars. The remaining percentage were registrations of alternative energies vehicles including GPL, electric cars and hybrid cars [10]. The adoption of new vehicles with alternative fuels has depended on the government's incentives such as tax reductions, subsidies or benefits on parking and tolls. The year when these incentives have been adopted, has impacted as well the development of fleets of alternative fuel cars in the different countries [19, 22]. According to data from the CCFA and ACEA, between 2018 and 2019, there was a rise of 60.9% in sales of EV and rechargeable hybrid cars in Germany while in France it was of 34.6%. In 2020, the sales of these alternative fuel cars increased significantly, achieving a rise of 262.9% in Germany and 202.4% in France with respect to 2019.

A continuous and important evolution of particular vehicles, and of transportation in

general, is expected during the coming years. In the current legislation, with the new proposals of *Fit for 55* [8], the European Commission expects to ban the sales of ICE cars by 2035, this means that even hybrid cars must be set apart from the roads, letting 100% of the particular vehicles market to alternative fuel systems. To achieve this goal within the expected term, by 2030 particular vehicles are expected to have reduced 55% of their CO_2 emissions.

2.3. The Vehicle Grid Integration

The VGI refers to the set of technologies, services and policies that create a link between transport and power systems. To achieve the reduction of carbon emissions from the road transport sector, there will be a strong development of EV in Europe during the next decades. Consequently, since there will be a few millions of EV on the roads, they could potentially bring a service of flexibility to the power grid through the implementation of some enabling technologies and policies.

Nevertheless, this integration can represent a challenge for the concerned parties and its success will depend on a coordinated multidisciplinary work and development during the coming years. The main involved stakeholders are electricity producers and suppliers, TSO, distribution system operators (DSO), regulators, flexibility and demand response operators, governments and car manufacturers. They must evaluate issues at different levels, going from drivers' behavior (for example when they will be invited to share their batteries' capacity for supporting the grid) to the expansion and adaptation of the recharge grid. To approach all these subjects and considering all stakeholders, a robust economic model must be settled.

The optimization of the VGI has already been subject of abundant literature, both from a technological point of view and from an economics point of view - starting from the pioneering work of [15] who introduced the concept of Vehicle to Grid (V2G) - and following a wide variety of "angles" such as the integration of RE_n, the minimization of recharging costs through electricity tariffs, or even the adjustment of voltage and frequency [4]. To implement all (or some) of these VGI services over the coming years, it is necessary to find a compromise between the needs of the networks and those of car drivers. For example, beyond the smart charging, VGI could offer a large variety of services to the network, by exploiting the possibility to restore the electricity available in the batteries of EV. These services are possible because, used to perform commuting, particular EV are usually idle more than 90% of the time (just like thermal vehicles), which makes them potentially available if they are connected to the electricity grid.

The integration of EV adds value to power grids and to the vehicles themselves. The question that emerges from this argument, and that has been the subject of several publications, seeks for the best way to take advantage of this added value. According to references [13] and [18], this value could come from thirteen different services associated with three stakeholders: **the wholesale market**, the link with the **DSO** and the interaction with **car owners**. Reference [20] presents a compilation of researches about

possible sources of income, which are mainly classified into four categories: minimization of operating costs, maximization of profit for the service rendered to the DSO, minimization of electricity generation costs for TSO and minimization of recharging costs for car drivers. In the reviewed literature, we find the value of VGI through the participation in grid services, investment deferral, improved efficiency and reliability of service and savings on costs of purchase and operation of EV. Furthermore, we consider that there is an immaterial and non-monetized added value of VGI that comes from the moral duty of contributing to decarbonize and preserve the planet.

Reference [29] presents in a concrete way the potential of remuneration of several V2X⁴ services in the United States, Canada, Australia, and United Kingdom. His results show that incoming value ranges vary greatly from one country to another with the same service. They also show a correlation between a possible remuneration and local circumstances in the place where the storage capacity is located, for example following the market conditions and the regulations in force. This remuneration will be maximized through participation in several services simultaneously. However, most of the work in the literature is focused on a single service and therefore, a single source of income not exploiting the full potential of VGI.

Adding value to VGI through the participation in the primary reserve service⁵ of a virtual battery, conformed by the aggregation of several batteries of EV, has been proposed through different models in the works of references [2, 14, 25, 33]. Authors of reference [4] present in their results a range of revenues per vehicle and per year for participation in frequency regulation subject to an auction system that varies according to the power levels to which EV are connected. The income obtained with a bidirectional system V2G is much higher than that of a single way system. The main argument for proposing the participation in frequency regulation, as reference [16] indicates, is that a battery can have a very fast response at a low cost compared to a traditional power plant providing the same service. In this work, we propose a different VGI valuing service, not in the balancing market (largely studied) but in the day-ahead market.

2.3.1. Charging systems requirement

The adoption of electric mobility implies an increase in electricity demand. The average electricity consumption of a citizen car is around 0.16 kWh/km. Thus, a fleet of 10 million electric city cars traveling 10000 km in one year, would represent 16 TWh of electricity demand. Their recharge might be performed in different ways that depend on drivers' behavior. For example, we talk about natural recharge when car drivers plug their EV and start up the charge at anytime of the day, without considering the power system condition. Such a massive behavior could challenge the balance of the

⁴V2X refers to Vehicle to Everything and includes all the possible services of EV such as vehicle to grid, vehicle to building, vehicle to vehicle or vehicle to home.

⁵It is an automatic device for frequency regulation with a response time between 15 and 30 seconds. All the primary reserve must be able to trigger off for a frequency deviation of 200 mHz. France must have a capacity of around 540 MW for this regulation. All countries participate in the primary reserve regardless of whether the imbalance comes from its own territory or elsewhere.

system during peak hours of electricity demand, and it will be more or less environment friendly depending on the electricity mix at the moment of the recharge. Thus, time and speed of recharge of an EV fleet are critical factors that can impact power grids balance at local or national scales. According to reference [6], EV represent lower carbon emissions with respect to Intern Combustion Engines (ICE) even after taking into account the whole lifecycle analysis. The power consumed to operate EV is the most impacting factor in their carbon footprint and therefore, enhancing the electricity used to charge EV batteries will make them a cleaner mobility solution.

The possible negative effects of EV integration can be mitigated by shifting charging periods through incentives for owners, for example with differentiated tariffs over time, direct control of charging (smart charging) or a two-way interaction between EV and networks (V2G). By adapting the typical use of EV with the new batteries services (with the purpose of supporting the electricity grids), we could expect the massive adoption of electrified transport and the acceleration of the benefits on air quality and the reduction of GHG emissions [18]. The idea of these recharge strategies is to find the most advantageous time and manner to charge EV [26]. This remains a large concept that could respond to a price signal, to the network saturation, to an electricity overproduction or to CO_2 emissions, for example.

Nonetheless, the adoption of EV fleets with different charging strategies could find several obstacles, not only technically but also associated to the complexity of EV owners behavior. As mentioned by reference [23], in the perspective of a possible business between an agreggator and drivers for doing VGI, we need to evaluate the possible barriers which could lead EV owners to refuse a proposed contract. They could be originated by a deficient communication of the justification for the service, privacy issues associated to the data exchange or the users concern about the loss of availability and control of their vehicles.

The work of reference [20] gathers the literature concerning the coordination strategies between EV and REn. They classified the interests of charging schemes into three categories: *costs*, for research about the minimization of total production and operating costs and the maximization of revenues for the concerned stakeholders (including the minimization of the cost of recharging for EV owners), *efficiency*, for research focused on optimizing the use, operation and management of REn, typically by charging the batteries when there are surpluses and by restoring energy when there are production shortages, and finally, *emissions*, for research on the positive impact of the use of batteries to meet the objectives of reduction of CO_2 emissions.

III. METHODOLOGY

We propose an empirical analysis of the storage system from EV as a device to help capacity expansion deferral for all kind of power plants (conventional and renewable)

and to decrease the total cost of production when progressively REn targets increase. This, by means of a better and stabler remuneration in the *day-ahead* market.

References [24] and [17] point out that the integration of more REn capacities will shift the electricity supply curve to the right since the production of these power plants will arrive at the base of the merit order function with their close to zero marginal cost. Both situations producing variability in the electricity market equilibrium are represented in Figure 2. The Figure 2 (a) corresponds to a typical case with equilibrium price $P1$. In Figure 2 (b) we represent the case where an important REn capacity is available; production from nuclear and thermal power plants shifts to the right and the equilibrium price $P2$ decreases. Finally, Figure 2 (c) represents the case where renewable capacity is low; production from nuclear and thermal power plants shifts to the left and the equilibrium price $P3$ is higher⁶. We consider that through a smart charging system for EV, a regulation of equilibrium prices might be applied to obtain benefits for the power system and the consumers.

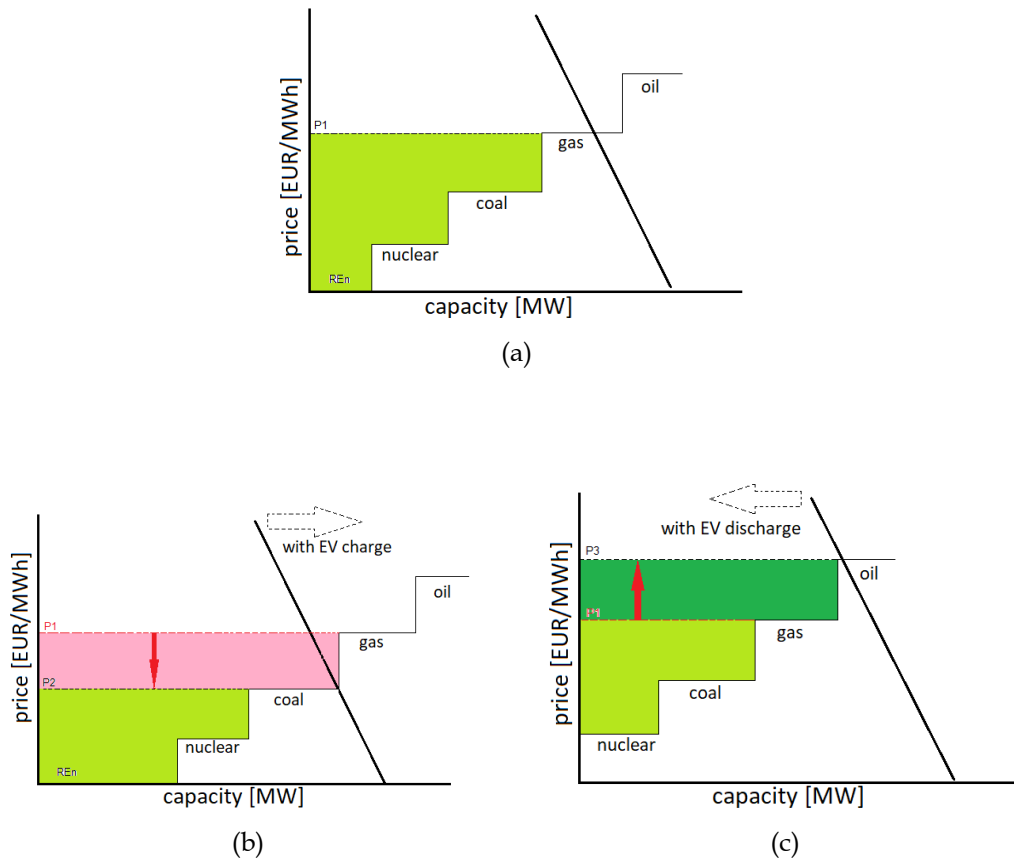

Figure 2: (a) typical merit order case (b) merit order effect with high REn production (c) merit order effect with low REn production. Source: authors.

Residual demand can be defined as the electricity supplied by non fatal energy sources. References [5, 28, 32] explain the importance and the impact of residual demand in

⁶The green areas correspond to producer's surplus. It is the integral of the zone limited by the horizontal of the equilibrium price and the offer curve.

electricity markets. They show that inelastic production from RE_n leads to a direct relationship between residual demand, supplied by conventional power plants, and market prices, and that this relationship is more direct than the one with the total demand.

Our methodology is based on the three main following elements. For our purpose, (i) we implement a bidirectional (V2G) recharge system algorithm that responds to a residual demand signal. Through peak shaving and valley filling we calculate a new residual demand curve. (ii) We estimate the electricity supply curve (merit order curve) and (iii) we estimate the new residual electricity demand curve considering the EV demand. From these estimations, we derive the economic impact of VGI on the supply demand equilibrium by calculating the producer's surplus and the CO_2 emissions. At first, we estimate the electricity supply curve through a polynomial regression for modeling the current price electricity system while analyzing the different relationships between residual demand, day-ahead market prices and CO_2 emissions. We estimate the new residual demand curve, obtained after the implementation of the charging algorithm, and with it, we recalculate electricity prices through the polynomial function that describes the market behavior.

3.1. Estimation of the merit order curve using a polynomial regression model

The assessment of the economic consequence of both RE_n power supply and uses of EV leads to estimate an electricity supply model able to reproduce the main failures, listed in section II.1, capturing the effects of the high RE_n penetration. For this purpose, we use an hourly time series of the year 2017 with data from ENTSO-E⁷ for calculating the residual demand as follows: from total demand we subtract production from on-shore wind, offshore wind, photovoltaics, run-of-river, biomass and waste. We choose to consider biomass and waste as fatal energies after an analysis of their behavior in the production system. These power plants do not have a variable behavior and therefore, represent a constant block in production. Whichever is the demand/supply situation, this electricity is primarily appealed and absorbed by the system as well as RE_n.

Following the work of reference [28], we estimate the supply curve with a polynomial function that fits the high and low spikes during the mentioned stressful system conditions for the economic evaluation of VGI.

3.2. VGI algorithm

The concern about a VGI algorithm increases in view of a bright perspective of the European EV market development. The accurate amount of an EV fleet might vary in different horizons, but certainly, it is expected to have some millions of EV in a close future. The need of managing the new load that these millions of EV represent is evident and should be planned. An effective and simple to implement control algorithm capable of providing economic and environmental gains is expected.

⁷European Network of Transmission System Operators for Electricity

The objective of the charging algorithm is the coordination and control of the timing and the amount of energy loaded on the grid and restoring this electricity afterwards in the case of V2G at an optimal moment as well. This dynamic might be applied for a significant expected EV fleet. There is indeed a wide amount of approaches taking different objectives and methodologies for solving the problem.

One of the upper level branches in smart charging research is the management of the charge by means of two different ways: a decentralized one, where a single EV optimizes its charge by its own, following a signal or a given criteria, and an aggregated one, where several EV are managed at the same time as a whole, following a signal or a criteria as well, that is sent and commanded by an only external agent [33]. All these control systems might take into account random events arisen from environmental conditions or EV owners behavior. Handling this uncertainty from a single EV routine is just not possible, thus researchers use statistical data for estimating the behavior of a fleet, which will correspond to a particular population [25] (e.g. a country with its habits such as different departure and arrival times, trip distances, etc. and its charging behaviors, such as the well known anxiety range or contrariwise, a frequently deep discharge behavior). Information about the batteries capacity and the charging points power and spread are also important for the analysis of the suitability of a smart charging adoption. Then, this information is used for simulating the charging/ discharging schedules according to different modeling frameworks which, in no case should jeopardize the main function of a vehicle: the one of transporting when it is required.

We propose a decentralized algorithm that responds to the future concerns of an EV fleet and that improves the current electricity mix dynamics. The general concept is to create a virtual battery composed of the sum of a part of each EV battery of a fleet of some millions vehicles taking into account the probability to be plugged to the grid. This whole capacity is managed in an optimal way, without aggregator and without any upward communication from cars (open loop), so that it will support the bulk power system for filling demand valleys through the smart charging and for shaving demand peaks through V2G. The algorithm optimizes the charge of the virtual battery through a one week period using a centered moving average. With this approach we represent an average charging with a peak shaving and valley filling behavior considering the expected load curve during the week and the week-end demand. Expected results of the algorithm implementation are:

- Easing REs integration through the compensation of its variability
- Limiting EV impacts on electrical power plants and transmission and distribution grids
- Reducing CO_2 emissions when limiting thermal power plants appeals and optimizing the use of controllable decarbonized power plants
- Limiting electricity price rises for users

The availability of EV for supporting the system is derived from the electricity demand

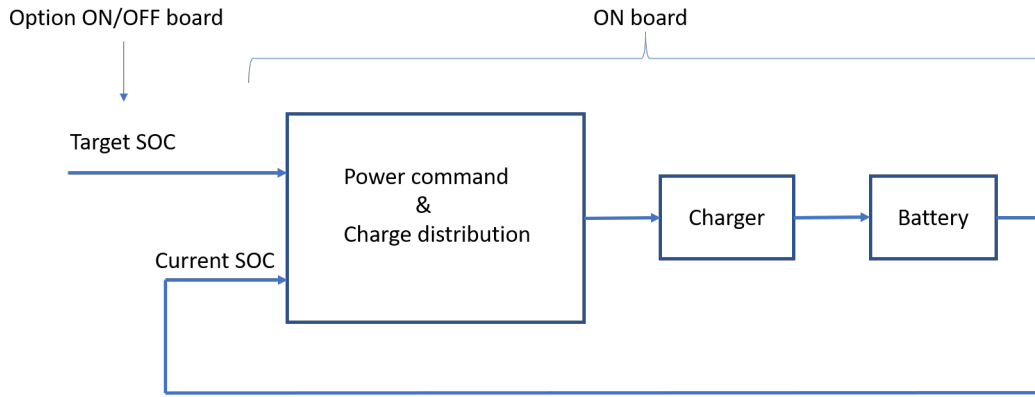

Figure 3: VGI algorithm diagram with specification of ON and OFF board elements. Source: authors.

for driving. The average consumption of one EV is 7 kWh per day and the important technological progress has led the automotive industry to produce EV with batteries of significant capacities like the Renault ZOE which has a battery capacity of 50 kWh. It is not necessary, and it is even not recommended, to fully recharge EV every day. Then, if a driver decides to let the EV recharge in an *automatic mode* and he/she establishes a minimal state of charge (SOC) (50% for example, leaving still an autonomy of more than 156 km), when the vehicle is connected and if the current SOC is greater than the minimal SOC, the algorithm will optimize the power charge distribution and a target SOC. Otherwise, if the current SOC is lower than the minimal SOC or if driver decides not to use this mode, the EV will charge at maximal power until reaching the maximal capacity.

The VGI algorithm uses one input signal which is defined from historical data which would be recorded in the EV for avoiding the communication requirement. Or else, it could be updated from time to time by any of the system operators (DSO/TSO) through smart metering solutions implemented now in several countries (for example through the control box *Linky* in France). We use a time series signal over which the optimization is performed. It could be any kind of data but for the purpose of this work and as we mentioned before, we implemented the VGI algorithm with a residual demand signal. The algorithm is composed of two parts. There is at first a general treatment where we generate a target SOC signal that will be used by all EV of the fleet. The target SOC is a percentage value that sets the level of charge of the virtual battery. The second part of the algorithm is carried out inside each EV and it is a power control. It manages the charge appealing the calculated power during the calculated time.

The charge of each EV follows a target power profile by time step t . Power $P(t)$ is managed at first by the target SOC at time T ($SOC_{target}(T)$) transformed in kWh in the EV into a settled range of maximal and minimal SOC and next, by a power profile $X(t)$ and its integral through the whole period T . Thus, the power is given by the following Equation 1.

$$P(t) = (SOC_{target}(T) - SOC(t)) \times \frac{X(t)}{\int_t^T X(t)dt} \quad (1)$$

Optimizing EV charge by following a residual demand signal is interesting from several points of view: it captures at the same time the main objective functions found in the literature for the different charging strategies. This is because residual demand is supplied by conventional power plants. Among these, thermal power plants bring the most variability for adapting production to demand (flexibility for reaching supply/demand equilibrium). A high residual demand means that production from thermal power plants is high and ceteris paribus production from renewable energies is low. Oil power plants have usually the highest prices in the market, followed by gas, coal and finally nuclear, hence, the highest the residual demand, the highest the market price and the highest the CO_2 emissions. Conversely, when residual demand is low it means that demand is low and renewable power generation is high. When thermal power plants are operating at low levels, market prices are low and CO_2 emissions are low. Therefore, as residual demand corresponds to the electricity supplied from conventional power plants, we can find a relationship between this value and the REn generation. Next, from REn generation we can find a relationship with CO_2 emissions and with market prices.

3.3. The electricity supply and demand equilibrium

As output from the algorithm we obtain a new residual demand curve which is expected to be less variable than the one without EV because of the peak shaving and valley filling strategy. Next, we are going to calculate the new electricity prices by time step using the value obtained by the equilibrium between electricity demand and supply. The result is a representation of electricity market prices in a system with VGI facility. We consider three main indicators derived from the simulations:

- The percentage of negative prices (number of periods of one hour during which the market prices are negative). This indicator reflects how the electricity storage capacities of the EV batteries avoid very low prices. It is defined in percentage.
- The producer surplus, classically defined as the surface between the equilibrium price and the supply curve which has been previously estimated with the polynomial regression.
- The CO_2 emissions, i.e., the sum of the emissions from the power sector (considering an average car and the average journeys).

IV. APPLICATION FOR GERMANY

Germany is an interesting case of study because of the important place it has in the two main dimensions of the VGI: it is a country that has reached REn adoption objectives faster than expected and it has had for long time the most important cars market in Europe, including EV market. A nearby impact of EV should be attended. For example, if there are 2 million integrated EV with a large battery capacity (as is the case of

new commercialized EV) and they are connected at 3.5 kW, the power grid would dispose of 7000 MW of flexibility. This capacity is comparable to the one of PSH plants in Germany which reach 6700 MW and it is not negligible compared to the 30000 MW of flexibility brought by the whole window of imports and exports (as seen in Fig. 1).

We applied the proposed methodology for this country using time series hourly data from 2019 as a reference period. It was a year with a specially high REn production, thus we can approximate a representation of the impact of this research in the close future when the REn capacity will be still more important [3].

4.1. Energy mix context

The structural changes of the energy mix in Germany takes place in the *Energiewende* starting in 2010. In 2011 Germany took over policies concerning nuclear exit and prioritized the shutdown of these power plants over the one of fossil power plants. The country passed from producing 25% of total electricity with 17 reactors to 12% with 6 reactors. The total shutdown of nuclear power plants is expected by the end of 2022. These political decisions entail an electricity balance purely from thermal power plants which include nowadays 84 coal-fired plants that, for its part, are expected to be reduced to 24 plants by 2022 and 8 plants in 2030. These will keep turning until 2038. Afterwards, the system balance will be provided by gas power plants.

By 2010, Germany had set the objective of producing 35% of its electricity from REn by 2020 in the energy transition trend. This objective is exceeded since 2018. The next transition stages aim to produce 50% of electricity from REn by 2030, 65% by 2040 and 80% by 2050. Moreover, with the accelerated success of the transition, the country decided to set the objective of 65% of REn by 2030⁸. By the end of 2019 Germany produced 40% of the total electricity demand from REn resources (Fig. 4). This renewable production was reached with an installed capacity of 123 GW, while conventional power plants had around 92 GW of installed capacity corresponding to 30 GW of hard coal, 23 GW of lignite, 28 GW of gas, 8 GW of nuclear and 3 GW of oil. With this power capacity mix, in 2019 electricity production was responsible of the emission of 362 gCO_2/kWh and a total of 219 M ton CO_2 in the year.

German electricity mix keeps changing constantly and it will still look differently in the coming years. According to energy political choices what is sure and certain is that production from thermal power plants is still necessary for ensuring the system's reliability and adequacy when absorbing REn variability. However, with a such an important production from REn, producers are facing a lack of long term incentives for staying in the market. We consider that thermal power plants subsistence, receiving a fair remuneration, is not against the transition goals neither the decarbonization goals till, on the contrary, without them it would be impossible to reach the equilibrium demand/supply at every time of the year.

⁸Data from IEA - www.iea.org/reports/germany-2020

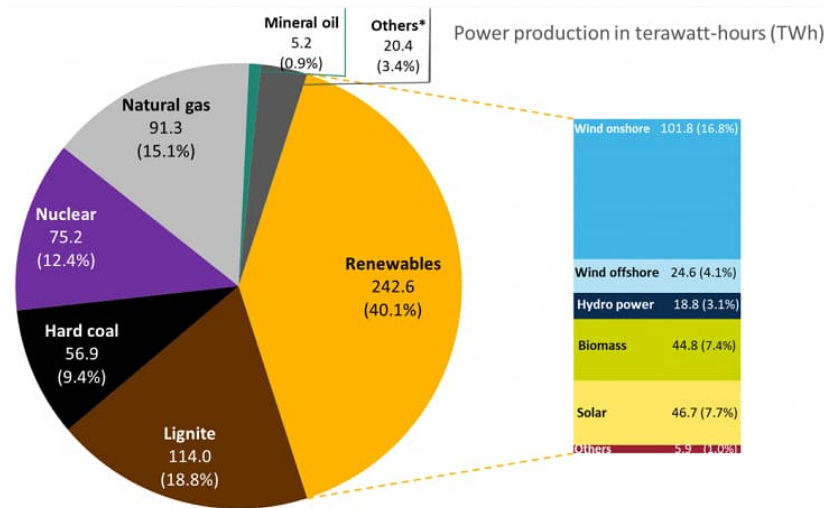

Figure 4: German electricity mix in 2019. Source : BDEW. Unit: TWh.

4.2. Electricity market

The largest part of the electricity production is commercialized in medium and long term contracts within periods that can vary from several months to several years. The remaining demanded electricity is commercialized on the electricity market. In 2019 Germany had the largest share in the EPEX Spot⁹ *day-ahead* market with 226 TWh over a total of 604 TWh¹⁰. This means that 63% was purchased in long term contracts and the remaining 37% of the total production passed through the market. For the purpose of this research we assume that the residual demand is the amount of electricity commercialized in the *day-ahead* market which means that we do not consider the existence of the *intra-day* market, which is a limitation of our methodology.

The German power system has a typical behavior as pointed out in Figure 5: because of the significant installed capacity, when residual demand is low, Germany fills its PSH reservoirs at first (which have a capacity of 6000 MW) and exports to neighboring countries until reaching the maximal physical capacities. There is an almost constant production from nuclear power plants and then, coal, gas and oil power plants adapt their production to residual demand. When demand is very high, Germany becomes an importer country and makes the possible variations on nuclear production while staying into the safe modulations.

4.3. Electric vehicle in the German car market

Germany has the largest car market in Europe. The country accounted on 47.71 millions of light duty vehicles by the end of 2019 and has the largest EV fleet in Europe with more than seven hundred thousand electric and hybrid vehicles registered since

⁹European Power Exchange. It operates the power spot markets for short-term trading in Austria, Belgium, Denmark, Finland, France, Germany, Great Britain, Luxembourg, the Netherlands, Norway, Poland, Sweden and Switzerland

¹⁰New trading record on EPEX SPOT in 2019. <https://www.epexspot.com/en/news/new-trading-record-epex-spot-2019> Consulted on 29th November 2021

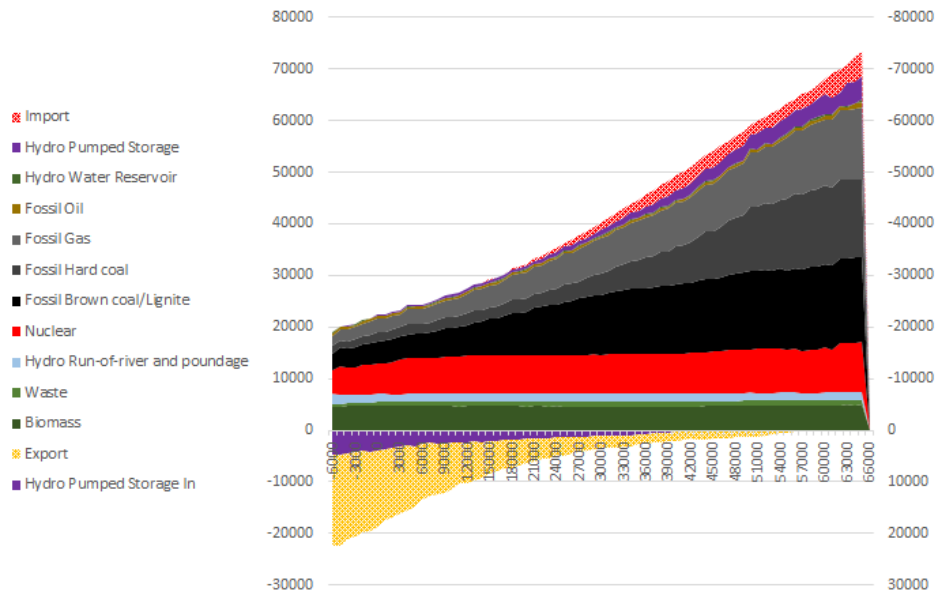

Figure 5: Electricity generation by power plant type as function of residual demand. Source: authors with original data from ENTSOE. Unit: MW.

2010. EV registrations passed from 108.839 EV in 2019 to 394.943 in 2020. The EV market share achieved more than 13% in 2020. This represents a raise of 262.9% in this market in the last two years.

Electric mobility is a major issue for the German government who has set the Objective of reaching from 7 to 10 millions EV by 2030 with 1 million public recharging points. For reaching the objective, and as consequence of the COVID crisis, the purchase bonus passed from 6.000€ to 9.000€. This bonus is offered now for purchasing new EV with a price lower than 40.000€ and there is as well a bonus for used EV and for plug-in hybrid cars.

About emissions in transport, the sector was responsible of 163 MtonCO₂ in 2019 in Germany¹¹.

4.4. Empirical results

We estimate the polynomial function for German conventional power supply prices using data from 2019. For this purpose we estimate the average values of electricity price by step of 500 MW. The estimated polynomial function of the *day-ahead* price P[elec] as a function of the electricity transaction [elec] is given by the equation (2).

¹¹Data from www.statista.com/statistics/989341/greenhouse-gas-emissions-by-sector-germany/

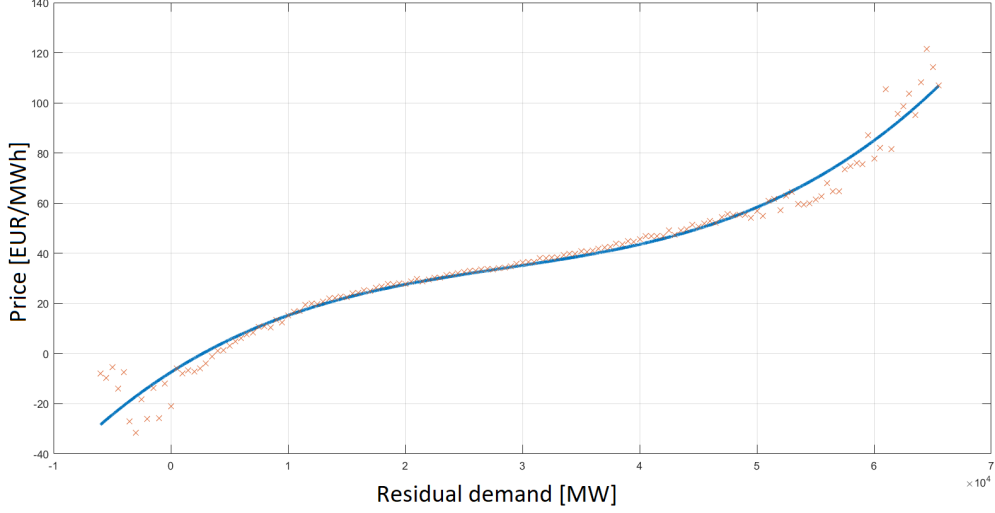

Figure 6: Electricity supply curve for conventional power unit: polynomial model estimation. Source: authors with original data from ENTSOE. Unit: €/MWh.

$$\begin{aligned}
 P[elec] = & \quad -7.48 & \quad +2.92 \times 10^{-3}[elec] & \quad -7.94 \times 10^{-8}[elec]^2 & \quad +9.26 \times 10^{-13}[elec]^3 \\
 & (98.02E - 2) & (1.42E - 4) & (5.89E - 09) & (6.46E - 14) \\
 R^2 = & 0.969 \\
 n = & 144
 \end{aligned}
 \tag{2}$$

Taking into account the German objectives by 2030, we apply the methodology to five different levels of EV : 2, 4, 6, 8 and 10 millions. For each one of these fleets we consider that half of it participates with V2G and half of it has only the smart charging function. The three indicators which have been calculated over one year are summarized in Table 2.

Screening the load curve and the price for a typical period of January (two weeks mid January) point out the hourly slots of car charging and discharging. Thus, Figures 7, 8 and 9 show the effect of VGI and the simulated electricity wholesale price for a 2 million, 6 million and 10 million EV fleet respectively for these two weeks in January. Figures 7 (a), 8 (a) and 9 (a) are the simulated load curves from the implementation of the VGI algorithm. We have shown the current load curve in blue, the smart charging of EV without the V2G facility (EV w/o V2G) in orange, the smart charging of EV with the V2G facility in red and the discharge of EV in black. The resulting charging corresponds well to the expected valley filling and peak shaving behavior when storing electricity in EV batteries during the hours of less demand and restoring this electricity during highest demand hours. Figures 7 (b), 8 (b) and 9 (b) show the simulated wholesale prices. We observe that prices follow the same behavior as the reference but that the curve is smoother, with less peaks and less valleys. We avoid the extreme situations of very high and negative prices and we stay as much as possible into the central range of the polynomial curve with prices between 20 and 80 €.

Table 2: Results for different EV fleets

Parameter	Ref	2M	4M	6M	8M	10M
Negative prices [%]	2.40	1.10	0.79	0.63	0.53	0.50
Producers surplus [M€]	6489	6192	6356	6534	6726	6940
CO_2 emissions [kg/MWh]	346	316	317	319	320	321

For the case of 2 millions EV we observe that the use of 2 or 3 GW of flexibility impacts electricity prices as expected. The resulting price curve tends to be smoother and the result is even more evident when increasing the number of EV. For the case of 10 millions EV we obtained a change in the highest peak from around 105€ to around 78€. However, this new proposition we are presenting, does not damage producers profitability since, during valley demand hours, electricity will be remunerated at a better price too.

The percentage of negative prices reduces as far as we increase the number of EV. Nevertheless, there is no strong improvement after 8 million EV. This could be explained because adding electricity storage capacities gives an important opportunity to store the largest RE power surplus. However, when we add a very large number of EV, this is less interesting than for the first capacities.

Resulting from the price evolution and the load curve evolution, the producer surplus is decreasing until 4 million of EV and then it is increasing. For more than 6 million EV, the electricity demand of the EV has a significant impact on the global demand and subsequently the revenues of the electricity sector. The minimum CO_2 emissions from the power sector are obtained between 2 and 4 million of EV: a strong increase of EV involve a largest power supply from the thermal units due to the share system.

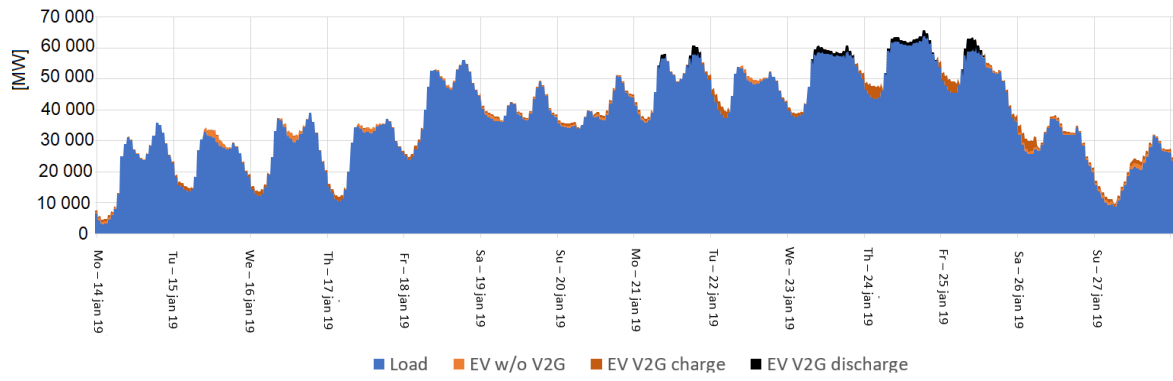

(a)

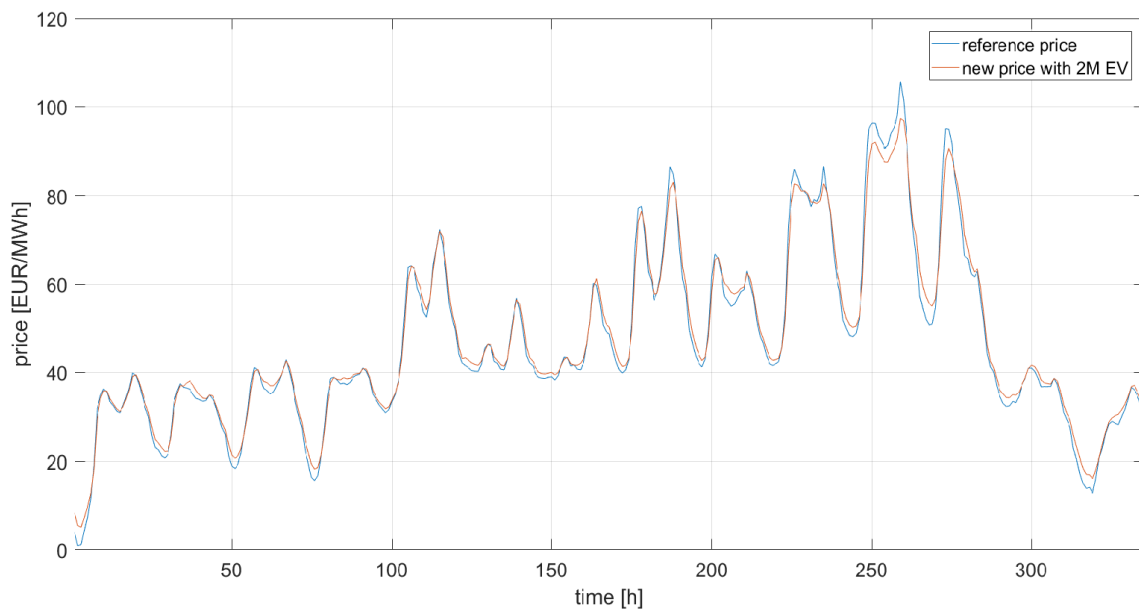

(b)

Figure 7: Results for a fleet of 2 millions EV. Source: authors.

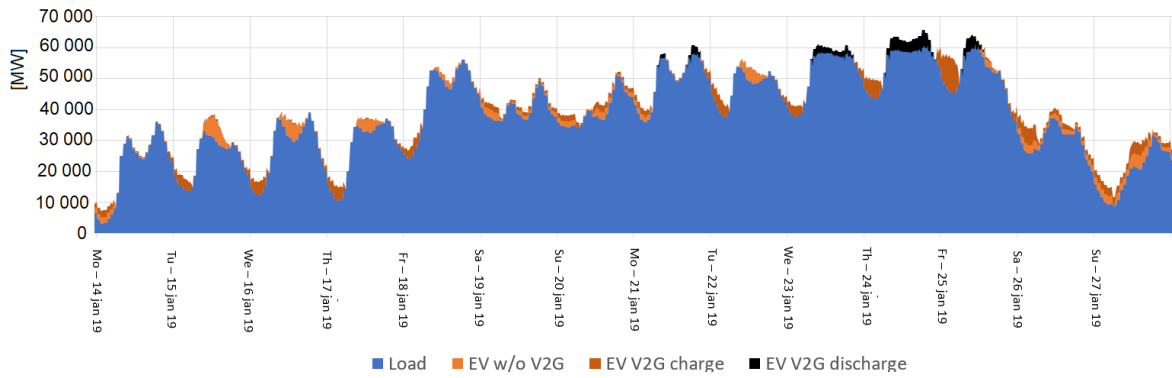

(a)

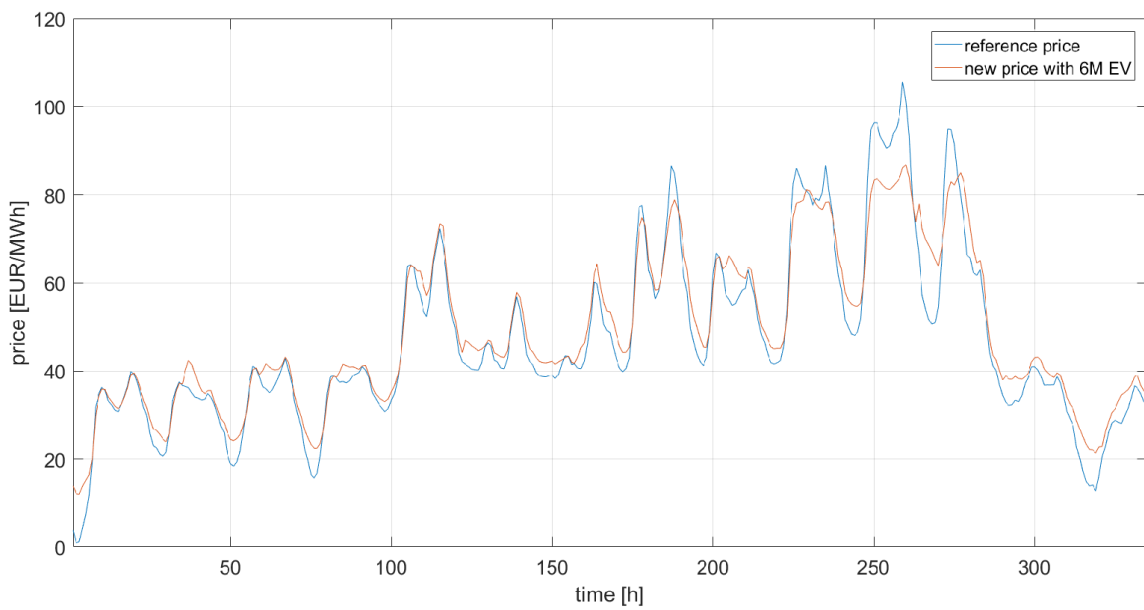

(b)

Figure 8: Results for a fleet of 6 millions EV. Source: authors.

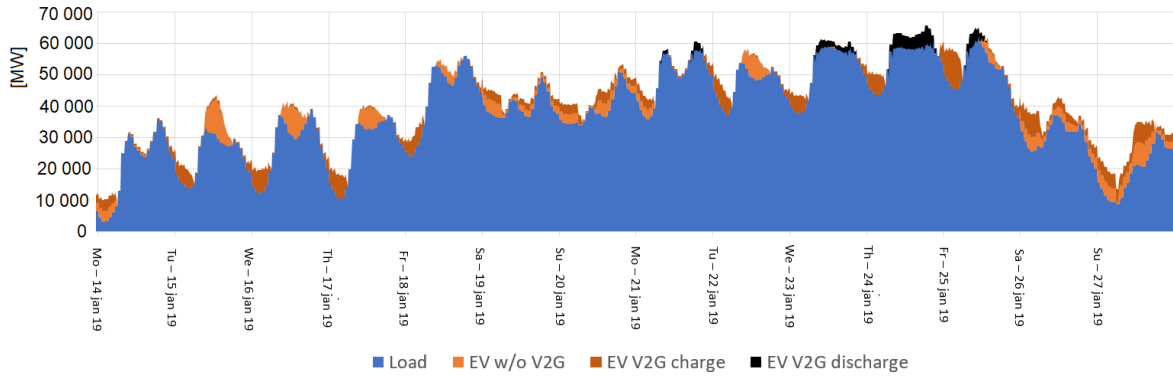

(a)

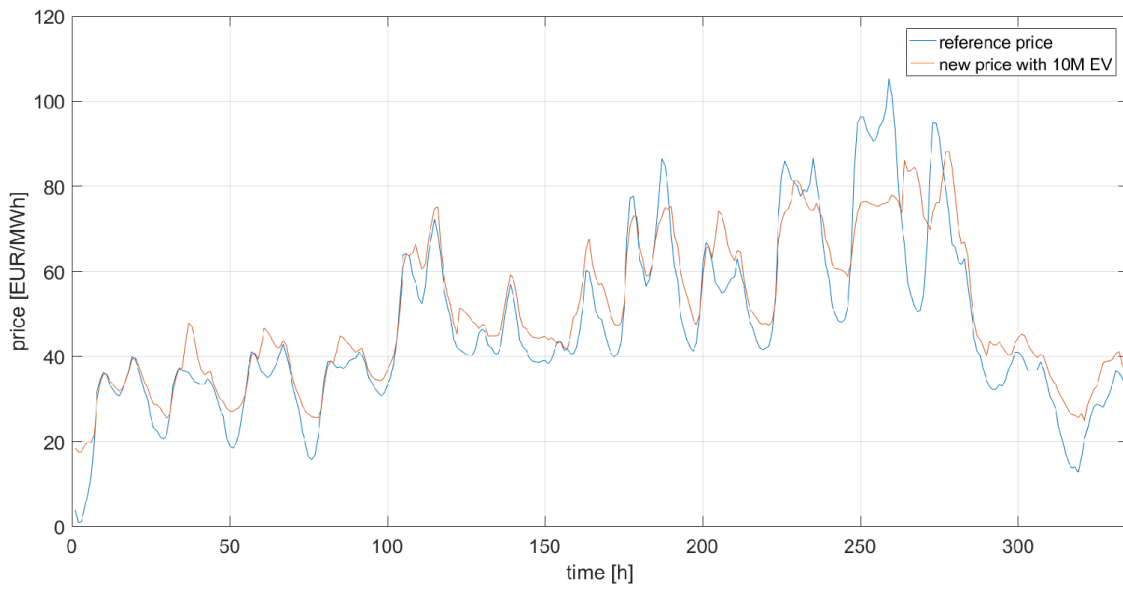

(b)

Figure 9: Results for a fleet of 10 millions EV. Source: authors.

V. CONCLUSION

In this paper, we assess the consequences of an increasing EV fleet on the power system considering an optimized VGI implementation. This analysis is performed in the European context of decarbonization policy perspectives. We develop modeling tools to study the interactions between EV charge and discharge and the power sector. We apply then to Germany which is characterized by a large share of REn supply (40.1% in 2019) and a very important passenger car fleet (47.7M in 2019). The optimized process of VGI is based on a peak shaving and valley filling mechanism considering the probability to be plugged on the grid. Instead of representing a new problem to the power grid because of the increasing electricity demand of the fleet, EV could become a flexibility resource for smoothing the effect of an evolving and more renewable electricity mix.

The peak shaving and valley filling optimization process has been designed considering the residual demand curve and the EV load curve. A simulation is applied for different sets of EV using historical demand data over one year. We assess the impact of modifying the load curve through smart EV charging on the wholesale electricity price, we estimate the producers' surplus and the power system CO_2 emissions. We apply this methodology to Germany which has both the biggest personal car fleet and the largest REn supply in Europe. We test several shares of electric vehicles in the global passenger cars fleet.

We confirm the interest of linking passenger EV to the bulk power system through VGI for supporting the emergent flexibility requirements. A fleet of EV could reduce the demand peaks that lead the system to stressful situations, therefore, an optimized charge/discharge process through the use of the VGI algorithm helps limiting the volatility brought up by the integration of REn and as consequence, improves the system's adequacy and reliability and could improve the producer surplus of the power sector. VGI limits investments risk in the power sector by reducing the price volatility and helps capacity deferral. When adding EV flexibility capacity, the system would need less investments in new generation capacity. Because the development of REn has been originally supported by large subsidies, which remain important until now, highest surplus should appear thanks to the flexibility brought by EV fleet.

The merit order effect on electricity markets, that shifts the curve through the right or through the left depending on the REn electricity generation, could step back. The flexibility of the German and French electricity grid is currently based on nuclear and hydro, which are non fossil fuel units. A virtual battery capable of absorbing this production (instead of limiting it) leads to a more stable and fair market.

We highlight the interest of optimizing an EV fleet charge following a residual demand

signal that captures inherently prices and CO_2 emissions while guaranteeing the performance of the system. We point out that EV have a significant impact on the electricity market. Nevertheless, the loop effect is not taken into account when optimization is done through a pricing signal in the revised literature. However, we have shown that EV charge changes the market prices.

References

- [1] Stefan Ambec and Claude Crampes. *Des prix négatifs pour l'électricité*. Oct. 2017.
- [2] Nataly Bañol Arias et al. "Assessment of economic benefits for EV owners participating in the primary frequency regulation markets". In: *International Journal of Electrical Power & Energy Systems* 120 (Sept. 2020), p. 105985. ISSN: 0142-0615. DOI: 10.1016/J.IJEPES.2020.105985.
- [3] David Benatia, Olivier Feron, and Clemence Alasseur. "Ring the Alarm! Electricity Markets, Renewables, and the Pandemic". In: *SSRN Electronic Journal* (2020). ISSN: 1556-5068. DOI: 10.2139/ssrn.3703117.
- [4] Paul Codani, Marc Petit, and Yannick Perez. "Participation of an electric vehicle fleet to primary frequency control in France". In: *International Journal of Electric and Hybrid Vehicles* 7.3 (2015), pp. 233 -249. DOI: 10.1504/IJEHV.2015.071639. URL: <https://hal-centralesupelec.archives-ouvertes.fr/hal-01266877>
<https://hal-centralesupelec.archives-ouvertes.fr/hal-01266877/document>.
- [5] Linh Phuong Catherine Do, Štefan Lyócsa, and Peter Molnár. "Residual electricity demand: An empirical investigation". In: *Applied Energy* 283 (Feb. 2021), p. 116298. ISSN: 0306-2619. DOI: 10.1016/J.APENERGY.2020.116298.
- [6] Agora Energiewende. *Lifecycle Analysis of Electric Vehicles*. Tech. rep. May 2019. URL: www.ifeu.de.
- [7] European Commission. *2050 long-term strategy*. 2014. URL: https://ec.europa.eu/clima/eu-action/climate-strategies-targets/2050-long-term-strategy_en.
- [8] European Commission. *Fit for 55*. 2021. URL: <https://www.ecologie.gouv.fr/fit-55-nouveau-cycle-politiques-europeennes-climat>.
- [9] European Commission. *Going climate-neutral by 2050*. 2019. URL: <https://op.europa.eu/fr/publication-detail/-/publication/92f6d5bc-76bc-11e9-9f05-01aa75ed71a1/language-en/format-PDF>.
- [10] European Commission. *Passenger cars in EU*. Sept. 2021. URL: https://ec.europa.eu/eurostat/statistics-explained/index.php?title=Passenger_cars_in_the_EU.
- [11] European Commission. *Quarterly Report on European Electricity Markets with focus on the developments in annual wholesale prices Market Observatory for Energy DG Energy Volume 13*. Tech. rep. European Commission, 2020. URL: https://ec.europa.eu/energy/sites/default/files/quarterly_report_on_european_electricity_markets_q4_2020.pdf.

- [12] European Commission. *Renewable energy directive*. 2014. URL: https://ec.europa.eu/energy/topics/renewable-energy/directive-targets-and-rules/renewable-energy-directive_en.
- [13] Garrett Fitzgerald et al. *The economics of energy storage. How multi-use, customer-sited batteries deliver the most services and value to customers and the grid*. Tech. rep. Rocky Mountain Institute, Sept. 2015. URL: http://www.rmi.org/electricity_battery_value.
- [14] Sekyung Han, Soohee Han, and Kaoru Sezaki. "Estimation of achievable power capacity from plug-in electric vehicles for V2G frequency regulation: Case studies for market participation". In: *IEEE Transactions on Smart Grid* 2.4 (Dec. 2011), pp. 632–641. DOI: 10.1109/TSG.2011.2160299.
- [15] Willett Kempton and Steven E. Letendre. "Electric vehicles as a new power source for electric utilities". In: *Transportation Research Part D: Transport and Environment* 2.3 (Sept. 1997), pp. 157–175. ISSN: 1361-9209. DOI: 10.1016/S1361-9209(97)00001-1.
- [16] Willett Kempton and Jasna Tomic. "Vehicle-to-grid power fundamentals: Calculating capacity and net revenue". In: *Journal of Power Sources* 144.1 (June 2005), pp. 268–279. ISSN: 0378-7753. DOI: 10.1016/J.JPOWSOUR.2004.12.025.
- [17] Jan Horst Keppler et al. "The Impacts of Variable Renewable Production and Market Coupling on the Convergence of French and German Electricity Prices". In: *The Energy Journal* Volume 37.Number 3 (2016). URL: <https://ideas.repec.org/a/aen/journal/ej37-3-keppler.html>.
- [18] Adam Langton and Noel Crisostomo. *Vehicle-Grid Integration A Vision for Zero-Emission Transportation Interconnected throughout California's Electricity System*. Tech. rep. 2013.
- [19] Wenbo Li et al. "A review of factors influencing consumer intentions to adopt battery electric vehicles". In: *Renewable and Sustainable Energy Reviews* 78 (Oct. 2017). ISSN: 13640321. DOI: 10.1016/j.rser.2017.04.076.
- [20] Francis Mwasilu et al. "Electric vehicles and smart grid interaction: A review on vehicle to grid and renewable energy sources integration". In: *Renewable and Sustainable Energy Reviews* 34 (June 2014), pp. 501–516. ISSN: 1364-0321. DOI: 10.1016/J.RSER.2014.03.031.
- [21] Marco Nicolosi. "Wind power integration and power system flexibility—An empirical analysis of extreme events in Germany under the new negative price regime". In: *Energy Policy* 38.11 (Nov. 2010), pp. 7257–7268. ISSN: 0301-4215. DOI: 10.1016/J.ENPOL.2010.08.002.
- [22] Lance Noel et al. "Willingness to pay for electric vehicles and vehicle-to-grid applications: A Nordic choice experiment". In: *Energy Economics* 78 (Feb. 2019). ISSN: 01409883. DOI: 10.1016/j.eneco.2018.12.014.
- [23] Jeannie Oliver and Benjamin Sovacool. "The Energy Trilemma and the Smart Grid: Implications Beyond the United States". In: *Asia & the Pacific Policy Studies* 4.1 (Jan. 2017), pp. 70–84. ISSN: 2050-2680. DOI: 10.1002/APP5.95. URL: <https://onlinelibrary.wiley.com/doi/full/10.1002/app5.95>.

- [24] Jacques Percebois and Stanislas Pommeret. "Storage cost induced by a large substitution of nuclear by intermittent renewable energies: The French case". In: *Energy Policy* 135 (Dec. 2019), p. 111067. ISSN: 0301-4215. DOI: 10.1016/J.ENPOL.2019.111067.
- [25] Marc Petit and Yannick Perez. "Vehicle-to-grid in France: What revenues for participation in frequency control?" In: *International Conference on the European Energy Market, EEM*. 2013. DOI: 10.1109/EEM.2013.6607307.
- [26] David B. Richardson. "Electric vehicles and the electric grid: A review of modeling approaches, Impacts, and renewable energy integration". In: *Renewable and Sustainable Energy Reviews* 19 (Mar. 2013), pp. 247–254. ISSN: 1364-0321. DOI: 10.1016/J.RSER.2012.11.042.
- [27] RTE. *Enjeux du développement de l'électromobilité pour le système électrique MAI 2019 PRINCIPAUX RÉSULTATS*. Tech. rep. RTE, May 2019.
- [28] Jan Smolen and Branislav Dudic. "The Role of Residual Demand in Electricity Price Analysis and Forecasting: Case of Czech Electricity Market". In: *International Journal of Energy Economics and Policy* 7.5 (Nov. 2017), pp. 152–158. ISSN: 2146-4553. URL: <https://www.econjournals.com/index.php/ijeep/article/view/5270>.
- [29] Andrew W Thompson. "Essais sur la participation des véhicules électriques sur les marchés de l'énergie : aspects économiques véhicule-à-réseau (V2X) et considérations relatives à la dégradation des batteries". PhD thesis. 2019. URL: <https://tel.archives-ouvertes.fr/tel-02461730>.
- [30] Arne Van Stiphout, Kristof De Vos, and Geert Deconinck. "Operational flexibility provided by storage in generation expansion planning with high shares of renewables". In: *International Conference on the European Energy Market, EEM*. Vol. 2015-August. IEEE Computer Society, Aug. 2015. DOI: 10.1109/EEM.2015.7216760.
- [31] Manuel Villavicencio. "Analyzing the optimal development of electricity storage in electricity markets with high variable renewable energy shares". PhD thesis. Dec. 2017. URL: <https://tel.archives-ouvertes.fr/tel-01808405> <https://tel.archives-ouvertes.fr/tel-01808405/document>.
- [32] Andreas Wagner. "Residual demand modeling and application to electricity pricing". In: *Energy Journal* 35.2 (2014), pp. 45–73. DOI: 10.5547/01956574.35.2.3.
- [33] Chenye Wu, Hamed Mohsenian-Rad, and Jianwei Huang. "Vehicle-to-aggregator interaction game". In: *IEEE Transactions on Smart Grid* 3.1 (Mar. 2012), pp. 434–442. DOI: 10.1109/TSG.2011.2166414.